



Work Beyond XAL at FRIB

Paul Chu / Vasu Vuppala

MICHIGAN STATE
UNIVERSITY



U.S. DEPARTMENT OF
ENERGY

Office of
Science

Outline

- Libraries built on top of XAL
- XAL in the big (HLA) picture
- Service-Oriented Architecture (SOA)
 - Data persistence
- XAL utilities and tools
- Prepare for future



Libraries Built on Top of XAL

- Many modules can be reused if packaged properly
 - Should not be final GUI applications but callable APIs
 - Modules can be called in services
- SLAC example

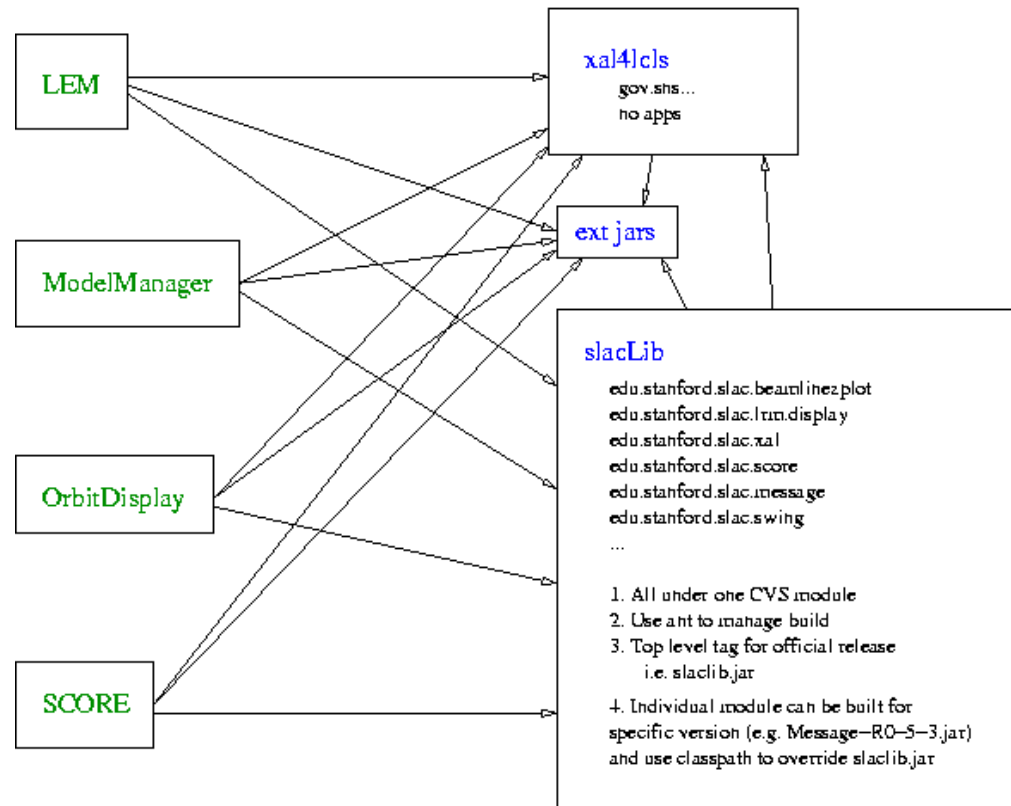

High-Level Application Architecture

- Hardware layer
- Control system interface
- Persistence layer
- API layer – XAL, solver...
- Application layer
- Other modules, e.g. multi-particle tracking code
- Components reusability
 - If properly architected
 - Can last much longer
- Integrated systems but can be deployed separately

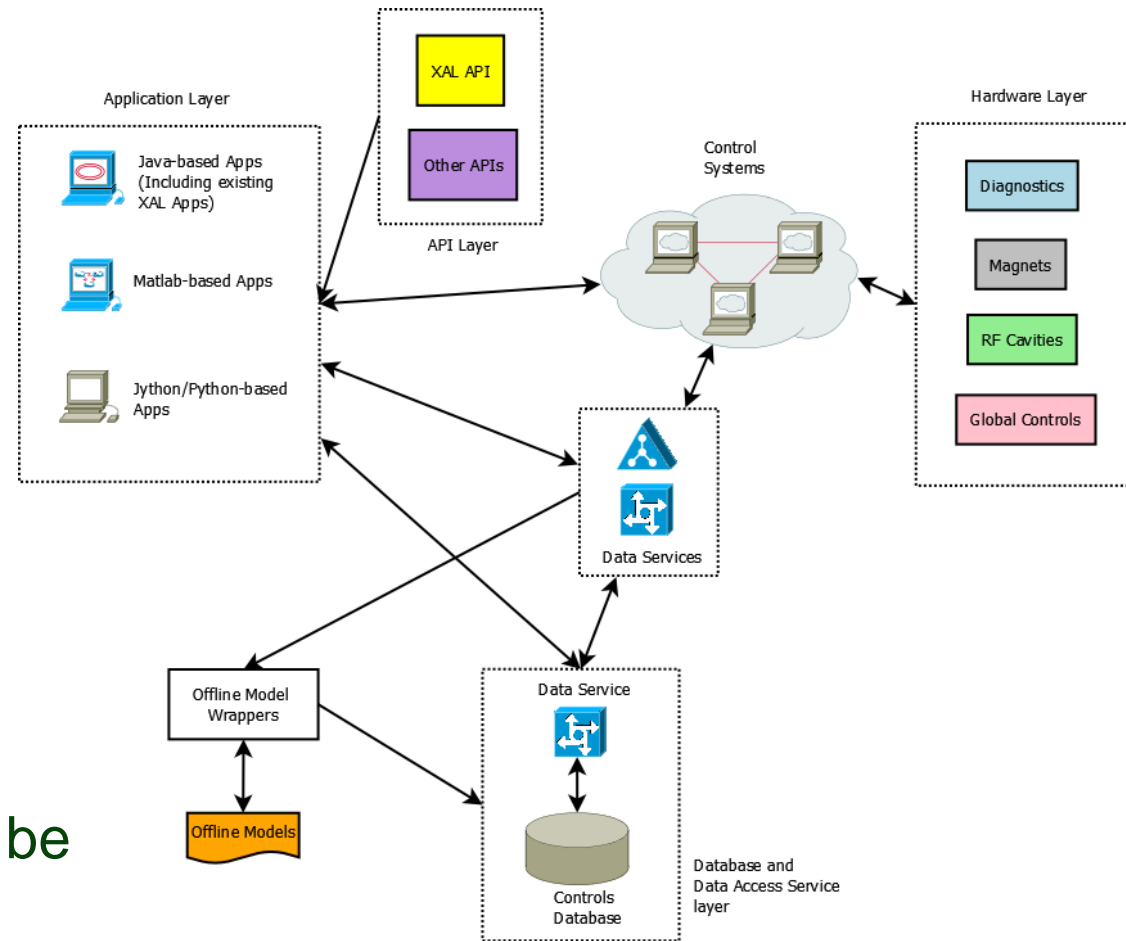

Service-Oriented Architecture

- Arrange applications' functions as services
- Thin client suitable for mobile devices
- Data persistence, e.g. RDB
- Computing power
- Service management
- Reusability
- Easy deployment
- Beyond SOA
 - Services can live in Cloud

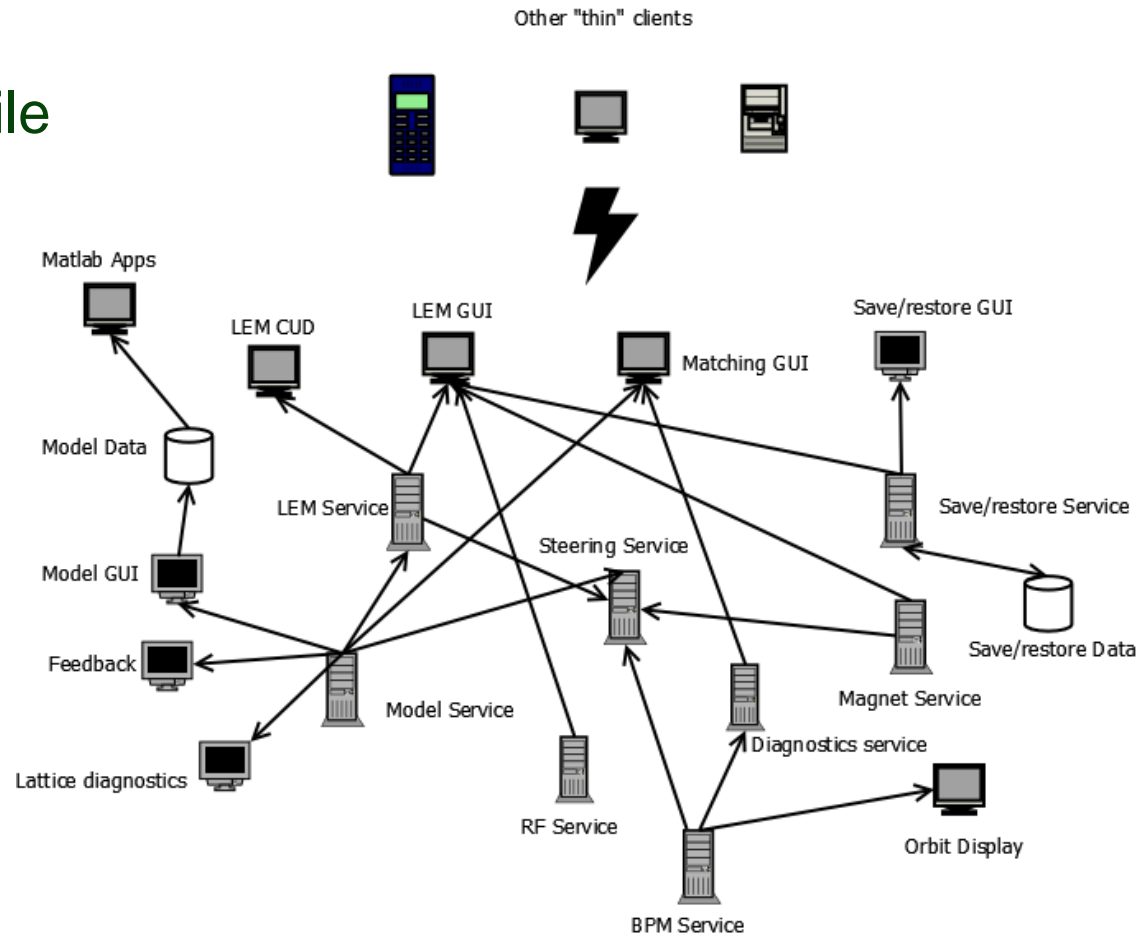

Data Persistence

- A standard data persistence mechanism should be provided, or every institute has to come up with own database for XAL data
- Standard data persistence can be accessed via Data API
- (RESTful) Data Service can build on top of the Data API
- Data Service can be a Cloud Computing Service
- In relational database
 - Lattice schema
 - Model schema
 - Save/restore schema
 - Physics data schema
 - » Scan application data
 - » Experiment data

Lattice/Model Schema

- Initial beam conditions as Model data
- All element related attributes are in property/value pairs so they are general enough for all accelerators
- XAL specific tables
 - RF Cavity table (containing RF accelerating gaps)
 - Transit-Time Factor (TTF) table for RF cavities

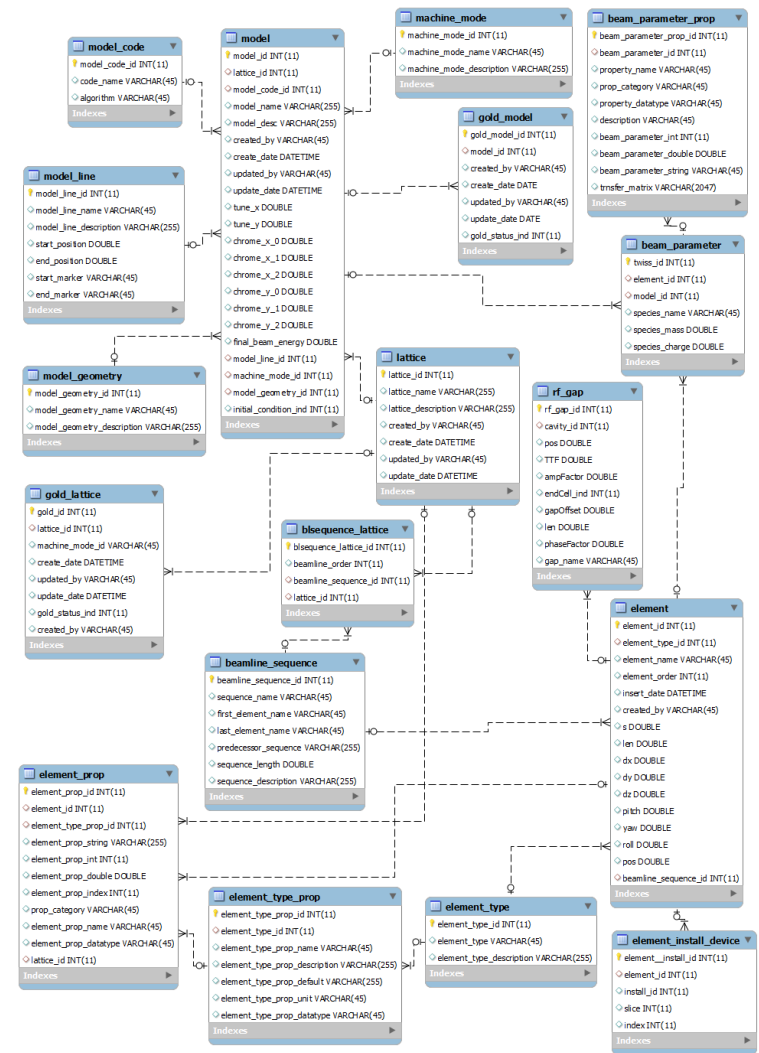

FRIB Data Upload

- A standard Excel file with multiple tabs
- All DB access via API (based on JPA)
- Device Settings or optimized lattice with settings w/ physics names
- Name mapping between the above 2
- Consolidate to 1 master file (Super Spreadsheet)

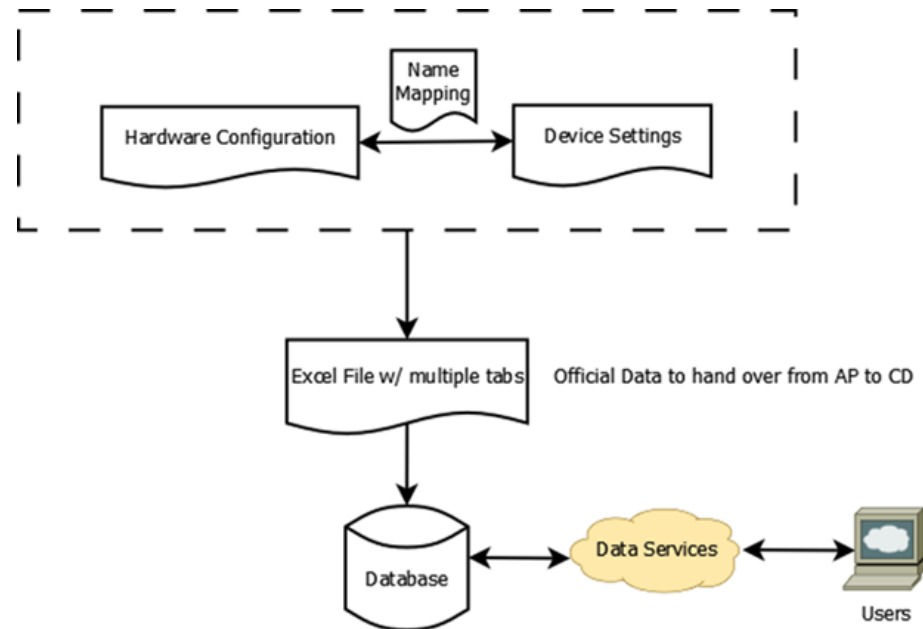

RDB Access with Java Persistence API

- Prototype RDB access with Java Persistence API (JPA)
 - New ORM Included in JDK 7
- RDB connection info set in persistence.xml
- Entity classes generated by NetBeans 7 IDE
- Scripting in JYTHON for RDB access is easy
- NetBeans has visual editor for Java GUI with JPA

```
import sys
from javax.annotation import Resource
from javax.persistence import EntityManager
from javax.persistence import EntityManagerFactory
from javax.persistence import PersistenceUnit
from javax.persistence import Persistence
from mydbtest import *
```

```
emf = Persistence.createEntityManagerFactory("fdbdevPU")
em = emf.createEntityManager()
userTransaction = em.getTransaction()
```

```
date = Date(112, 3, 3, 15, 10, 0)
newModel = Models()
#set comments
newModel.setComments("Test persistence")
# set date
```

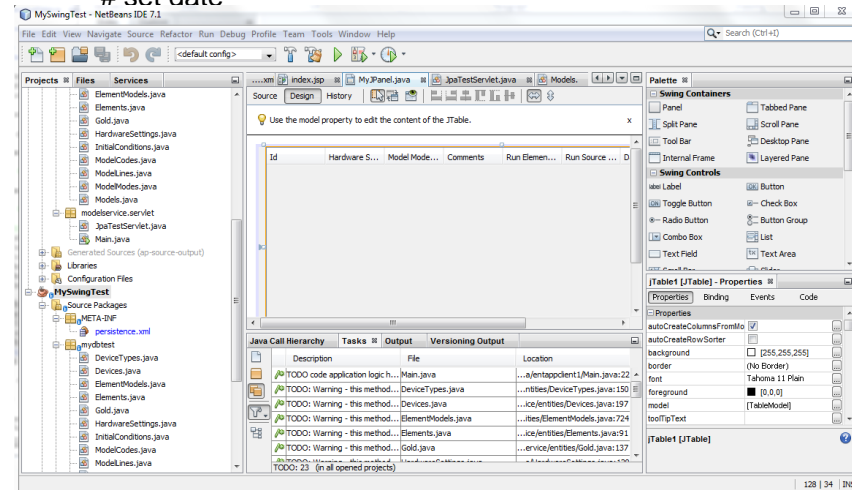

XAL Utilities and Tools

- Database API and XAL API should be similar, if not identical
- Security package
- GUI widgets – use JavaFX?
- Data plotting package

Prepare for Future [1]

- XAL setup should be much easier
 - A standard spreadsheet template should be sufficient
 - Database generated
 - Spreadsheet data uploaded to DB
 - XAL files generated from DB
- Third party solver/optimizer as service
- Third party modeling tools, e.g. FEL model, multi-particle tracking
- Everything should be Web compatible

Prepare for Future [2]

■ Cloud Computing

• Advantages

- » No capital IT cost – pay per use
- » Failure as a feature – recover seamlessly
- » Expandability

• Services

- » Storage-as-a-service
- » Database-as-a-service
- » Information-as-a-service
- » Process-as-a-service
- » Application-as-a-service
- » Platform-as-a-service
- » Integration-as-a-service
- » Security-as-a-service
- » Management/governance-as-a-service
- » Testing-as-a-service
- » Infrastructure-as-a-service

*“Cloud Computing and SOA
Convergence in Your Enterprise”*
D. S. Linthicum

Controls Database Collaboration

- Requirements
- Proteus: Configuration
 - Graphical User Interface
 - Application Programming Interface
 - » Matlab, Python, Java
- Proteus: Naming System
- Current Status
- Integration
- In Development

CDB Requirements 1

#	Database	Description	
1	Component	Physical and logical information about the machine and its component systems	
2	Infrastructure	Cables, IOCs, Racks, Rooms etc	
3	Lattice	Location, length, setting and/or signal records	
4	Model	Physics model	
5	Logbook	Logbook entries	
6	State	Save/restore state of FRIB segments	
7	Alarm	Set changes, set/read mismatches	
8	Inventory	Spare parts, stock items	

CDB Requirements 2

#	Database	Description	
9	Physics	Results from physics experiments	
10	Traveler	Production, test, design data	
11	Maintenance	Preventive maintenance data, failure analysis, lifetime analysis	
12	Operations	Beam statistics, run hours, beam on target, shift summary, downtime, bypass records	
13	MPS	Machine state dumps	
14	FRIB Requirements	Parameter list, system and component requirements	
15	Interlocks	Interlock hierarchy information [optional]	

Application Architecture

■ Application layer

- Operator interfaces
- High-level applications
- Libraries

■ Service layer

- Access to data
- Programming Interface

■ Data layer

- Managed data
- Instrument data
- No direct access

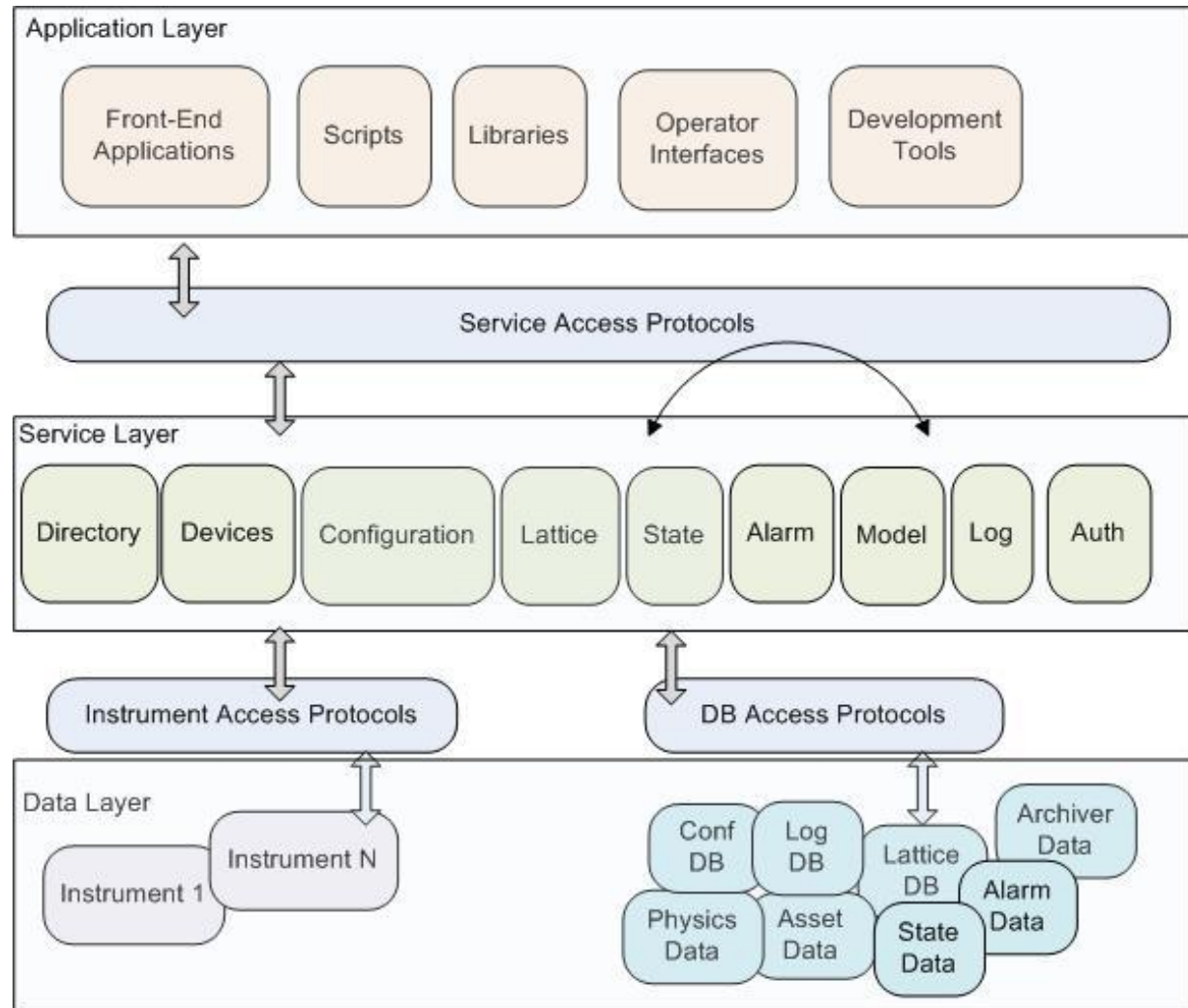

CDB Schema Domains

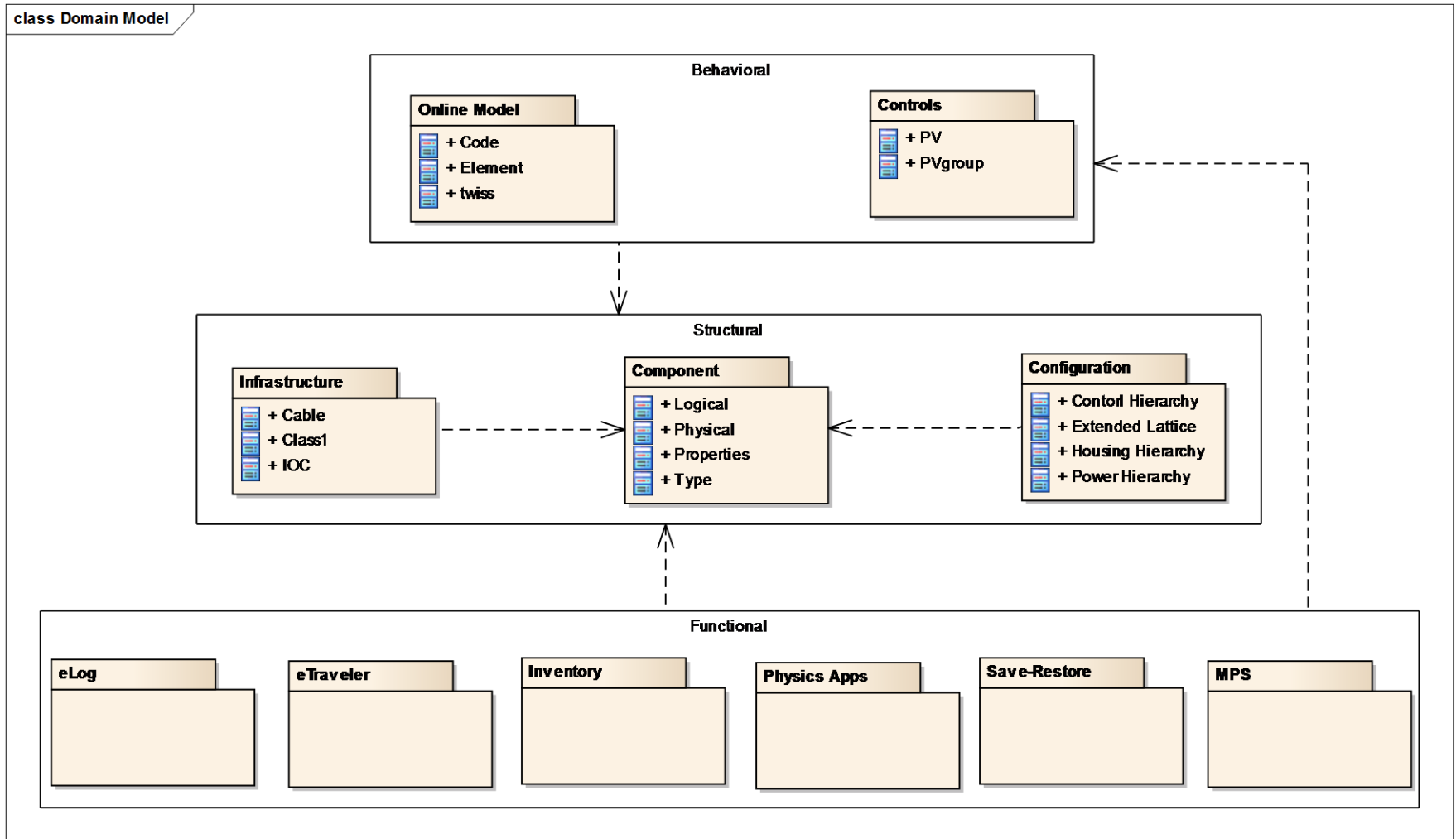

Collaboration Goals

- Be Like EPICS for Data Services
 - Easy to Install
 - Easy to Configure
 - Extensible
 - Well-Defined Interfaces
 - Documentation
 - Training
- Domain Goals



Status - Summary

- Logbook : In production at FRIB and BNL
- eTraveler : In production at FRIB
- Machine Configuration Tool: In production at FRIB
- Save/Restore: In production at BNL
- Model: Under development at FRIB and IHEP
- Signals: Under development at FRIB and BNL
- Physics Applications: Under development at FRIB
- Authentication: Under development at FRIB

Partners

- Brookhaven National Lab, New York, USA
- Facility for Rare Isotope Beam, Michigan, USA
- Institute for High Energy Physics, Beijing, China

Demo

- Proteus: Configuration
 - Graphical User Interface
 - Programmatic Interface
- Proteus: Naming System
 - Graphical User Interface
- URL: <http://controls.frib.msu.edu>
 - Under “Applications” Menu

Integration

- **E-Traveler**
 - Devices from Configuration Database (In Production)
- **E-Log**
 - Logbook Entries for a Component (Under Development)
- **Valid Name**
 - Naming System Checks for Validity and Already Assigned Names (Under Development)
- **Online Model**
 - Machine Configuration as Input to XAL (Under Development)

Under Development

- Integration with Control System
 - Real-Time Signal Values
- More Data
 - Properties, Alignment, Measurements, CAD Drawings, Location, Cables
 - Etc.
- EPICS V4 Interface
 - pvget, eget
- Graphical Hierarchy
- Comprehensive Search
- GUI Improvements

Development Approach

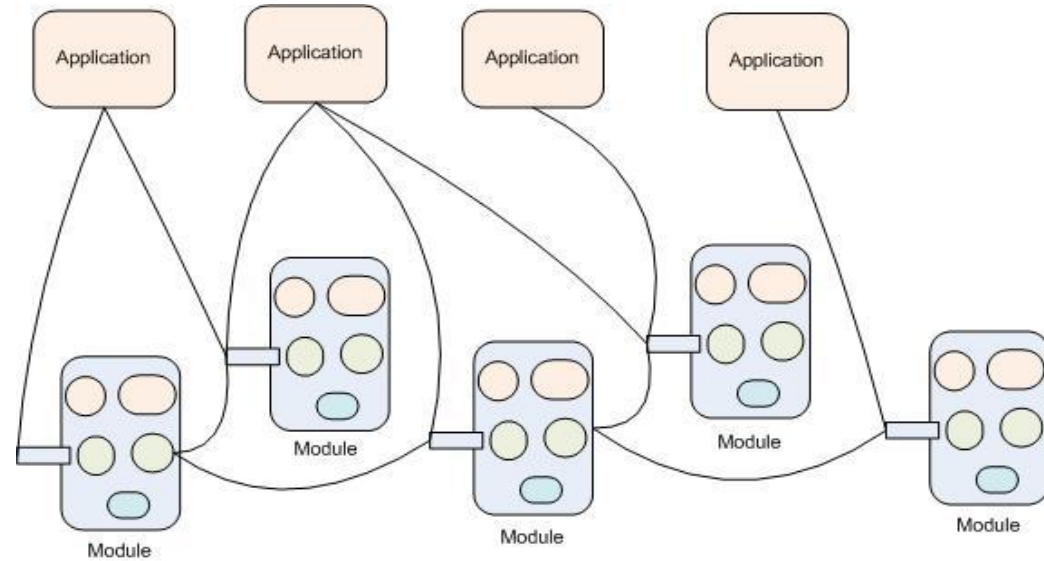
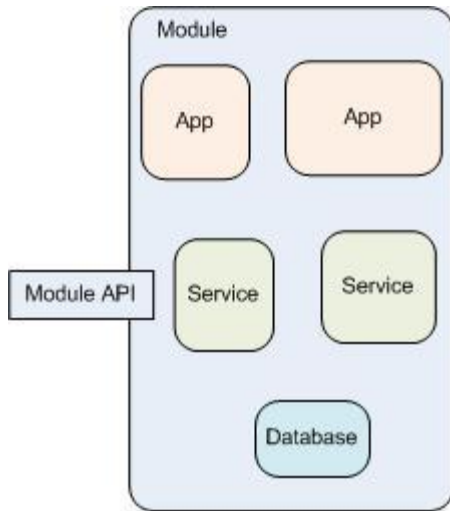

- **Module**
 - Database
 - Module Applications
 - Module Services
 - Module API

- **User Applications**

Development Approach - Interfaces

- Service API
- Language Binding API
- Data API
- Module API

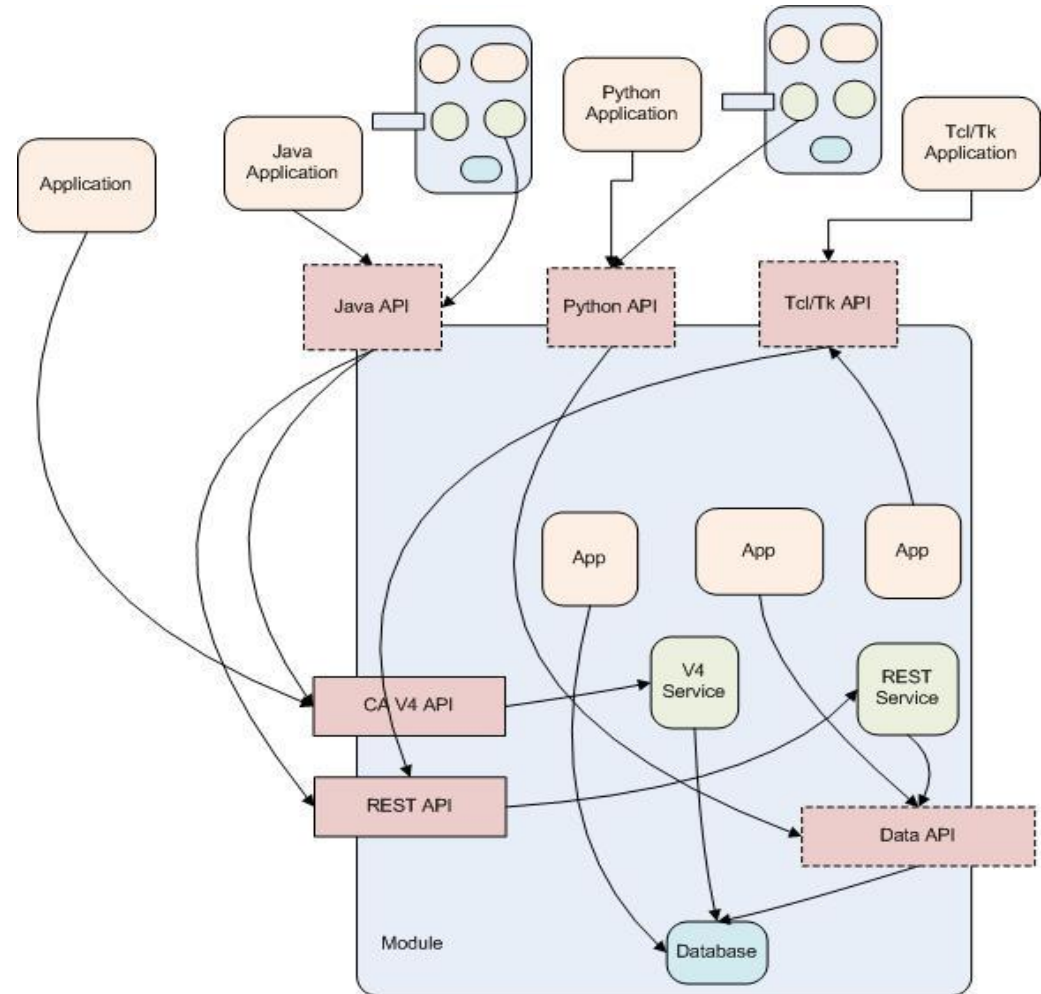

Suggested Development Strategy

1. Schema
2. LB API
3. Data API (optional)
4. LB API Switches to Data API
5. Service API
6. LB API Switches to Service API

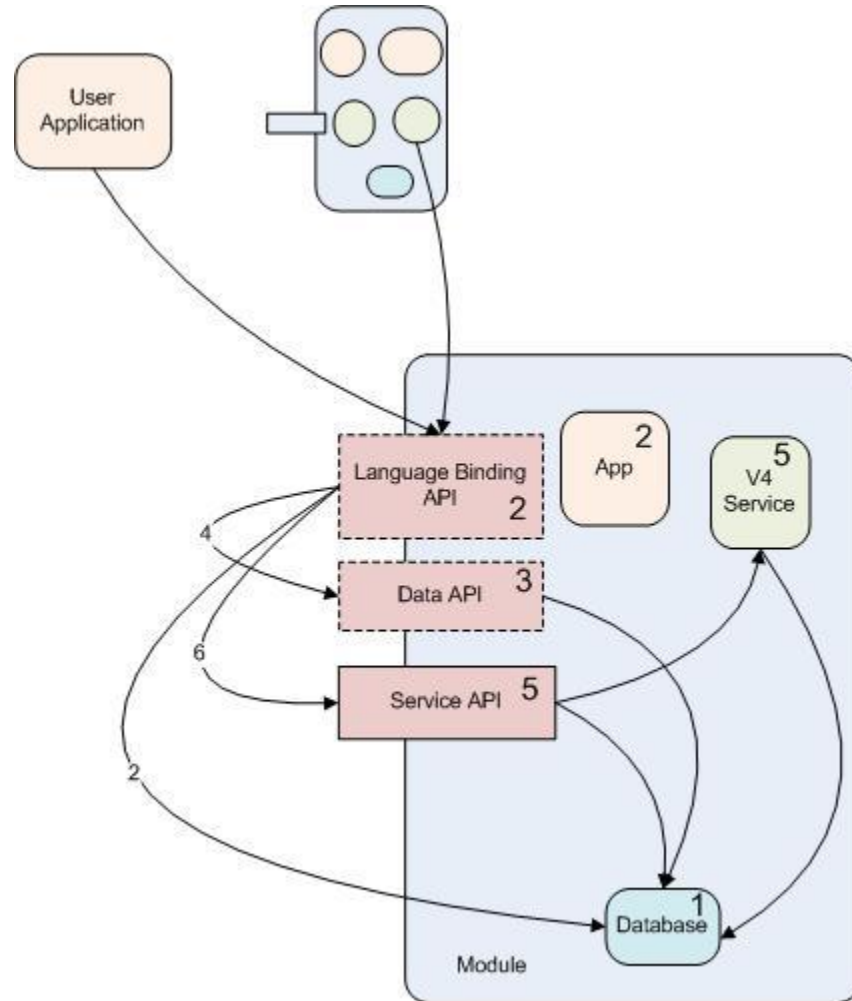

EPICS V4

- Next Version of EPICS
- Expands to Non Real Time Data
- Pvget, Eget
- Directory Service
- Channel Finder
- <http://epics-pvdata.sourceforge.net/>

Technologies & Infrastructure

■ FRIB:

- MySQL
- REST, EPICS V4
- Java
 - » JPA, EJB, JAX-RS
- PHP, Python
- Mercurial, Git

■ BNL:

- Python
 - » Django
- Java
- Mercurial, Git

■ Infrastructure

- Sourceforge
- Google+
- Launchpad

Challenges

- Differing Deadlines, Priorities, Technologies, Processes, Terminologies
- Integration
- Making it a Product
 - Generalization
 - Packaging
 - Documentation
- Data Migration
- Performance
- User Interfaces
- Not a Typical Project

Conclusion

- Collaboration started in November 2011
- Weekly Meeting
- Quarterly Review
- Goals, High-Level Requirements, Architecture Defined
- Some applications in production, some in development, and some not initiated
- Several challenges
- Need more collaborators